

Tech Note : Optimal Low Noise Floors in Phase Noise Testing Using External References

This application note describes how using external references can be useful for speeding up measuring the phase noise of very low noise reference sources.

Introduction

Using the PNT with cross-correlator and external references provides the benefit of faster measurement speed when measuring ultra-low single sideband (SSB) phase noise of devices under test (DUT). When using BNC's PNT signal source analyzer, the choices are:

- Standard internal references
- Option LN: close to carrier ultra low noise internal references
- Voltage tunable external references.

Figure 1 below illustrates the phase noise sensitivity of the PNT for a single correlation (16 sec measurement time) for a 10 MHz DUT signal. The phase noise sensitivity indicates how low at a given offset from the carrier the DUT phase noise can be to be measured accurately. A DUT having a phase noise below the phase noise sensitivity requires either additional correlations (increasing measurement time) or cannot be measured at all.

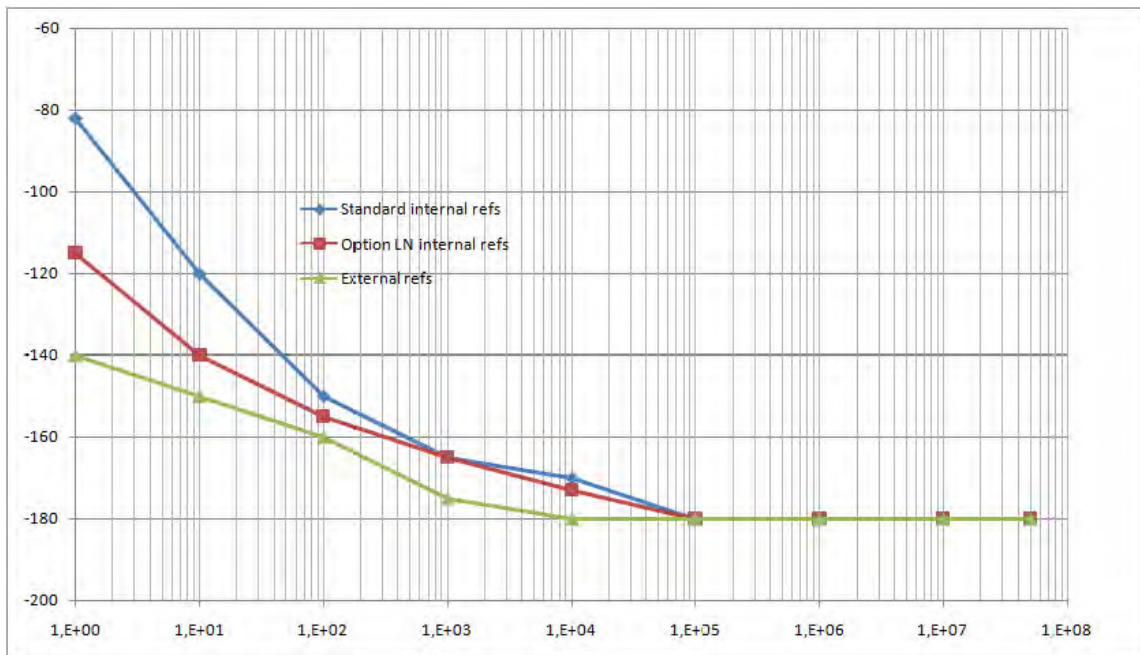

Figure 1: Phase Noise Sensitivity of PNT System with Different Measurement Options (1 correlation, 10 MHz, 16 seconds measurement time)

Figure 2 below shows the phase noise sensitivity after 1000 correlations: approximately 5 hours of measurement time. In this example, a 10 MHz low phase noise OCXOs with an expected phase noise of around -105 dBc/Hz at 1 Hz offset is to be measured. It becomes very apparent that after 1000 correlations, it will be difficult to measure such a device with standard internal references.

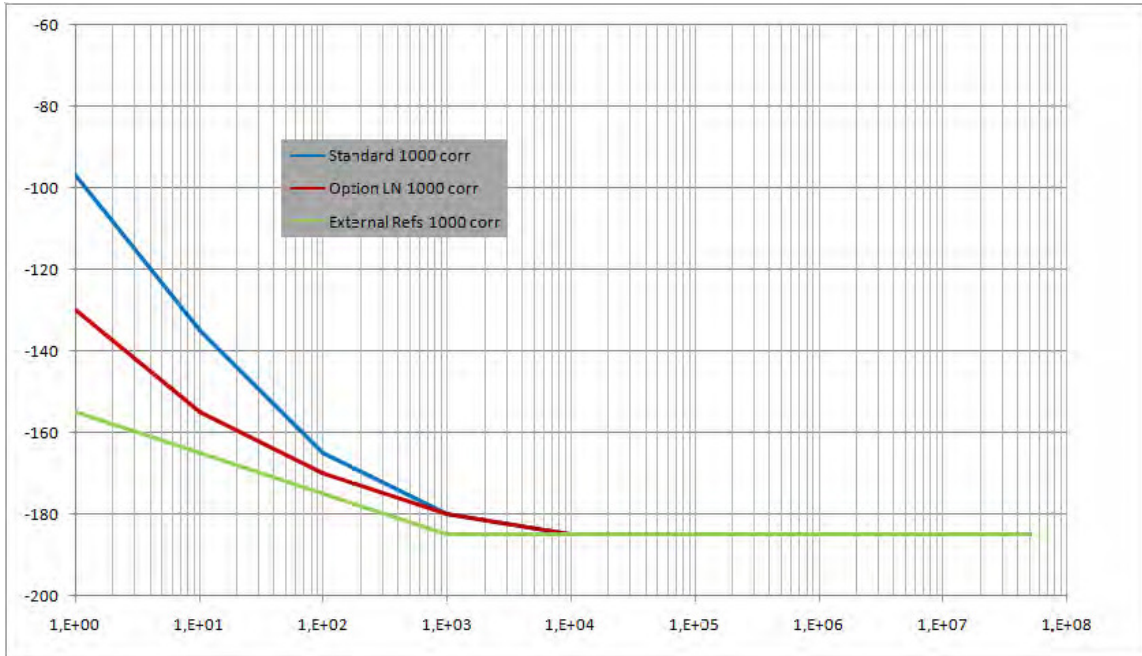

Figure 2: Phase noise sensitivity of PNT system with different measurement options (1000 correlation, 10 MHz, 5 hours measurement time)

The Limitations of Standard Internal References

Figure 3 below shows the corresponding results after 1 correlation (green trace) and 200 correlations (red trace). For offsets 100 Hz and more the traces are identical. However, for offsets below 100 Hz the measurement is limited by the phase noise sensitivity of the PNT using standard internal references. Even after 200 correlations and 1.5 hours measurement time, the 1 Hz offset has not reached the expected value. Additional correlations and hours of measurement time is needed to obtain the actual result.

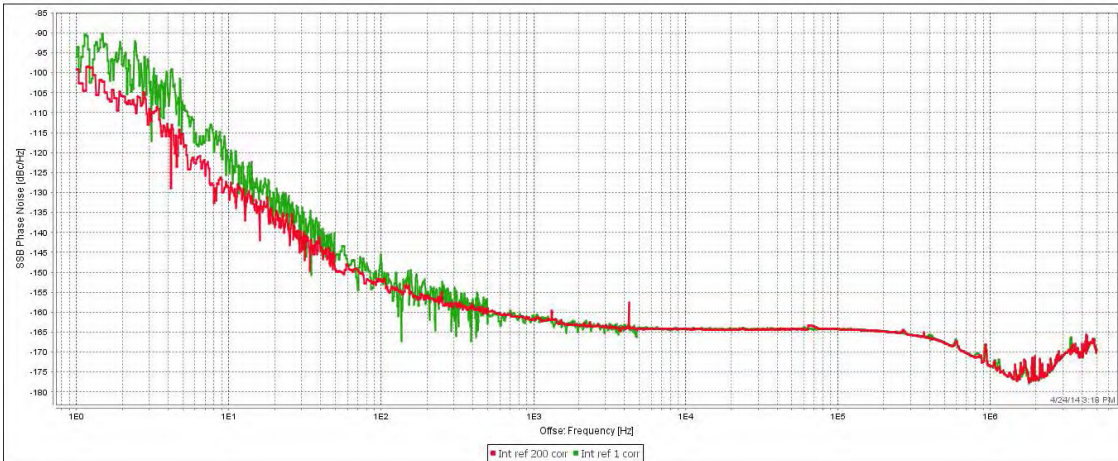

Fig. 3: Phase noise measurement of low-noise 10 MHz OCXO (1 correlation, standard internal references, 200 correlations, 90 minutes measurement time)

The Measurement Setup Using External References

Alternatively, external references can be used that result in a substantially lower phase noise sensitivity at low offset frequencies. The block diagram of the measurement setup is shown below in Figure 4. Two 10 MHz OCXOs have been used as external tunable references. Both references shown here are through hole mounted test fixtures, and are supplied using the optional two low-noise internal supplies of the PNT. Each reference OCXO output is connected to the RF IN port of one of the PNT reference inputs, and each tuning port of the OCXO is connected to the corresponding tuning output port of the PNT. Therefore, the external references are fully controlled (biased, and tuned) via the PNT. The DUT signal is fed into the DUT port.

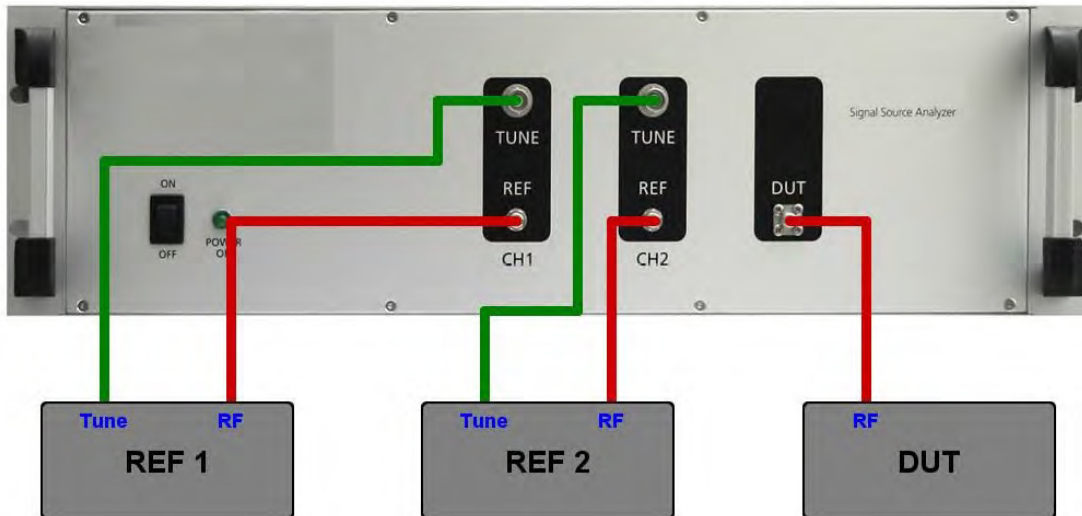

Figure 4: Connectivity Block Diagram as Provided by the PNT GUI Software

The actual measurement setup is shown below in the photograph in Figure 5.

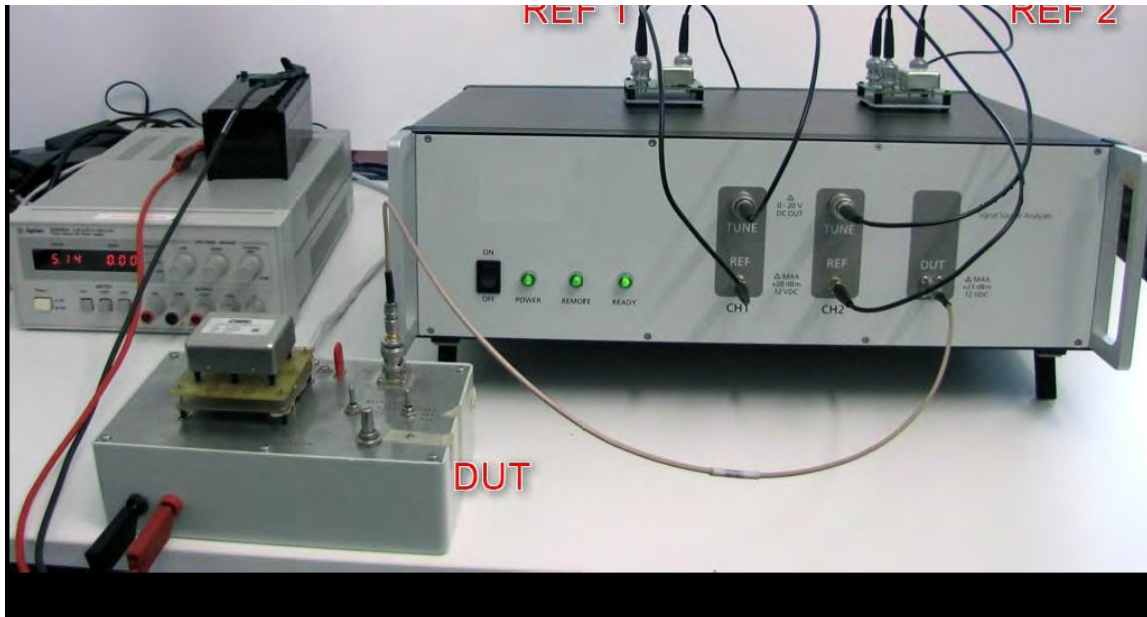

Figure 5: Photograph of Measurement Setup

The GUI Setup

In the PNT GUI, the setup is straightforward. First, and only if desired, enable low-noise internal power supplies to power the external references. As shown below in Figure 6, in the Supply Configuration menu both supplies have been enabled and set to 5.1V and supply a current of more than 550 mA per channel during startup of the OCXO.

Alternatively, the external references may be powered from external power supplies.

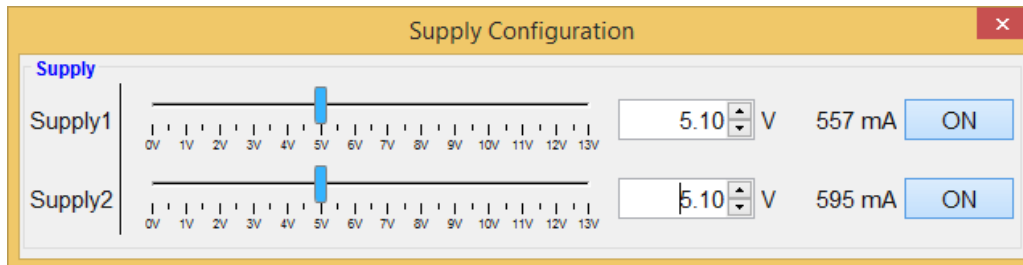

Figure 6: Supply Configuration Menu

Both supplies are set to 5.1V and during OCXO startup, draw about 550 mA per channel.

Next, the external references require a short calibration sequence of the external references to determine the tuning constant. In the Advanced Measurement Configuration menu, the tuning voltage range is set for each channel. In this case, a tuning range from 0 to +10 V is used. The **Meas** button then executes the calibration measurement. In this example, the calibration reveals respective 2.60 Hz/V and 2.57 Hz/V tuning sensitivities on the two channels.

Note: This calibration must be performed only once during the setup. Only if a reference is replaced, the corresponding calibration step must be repeated.

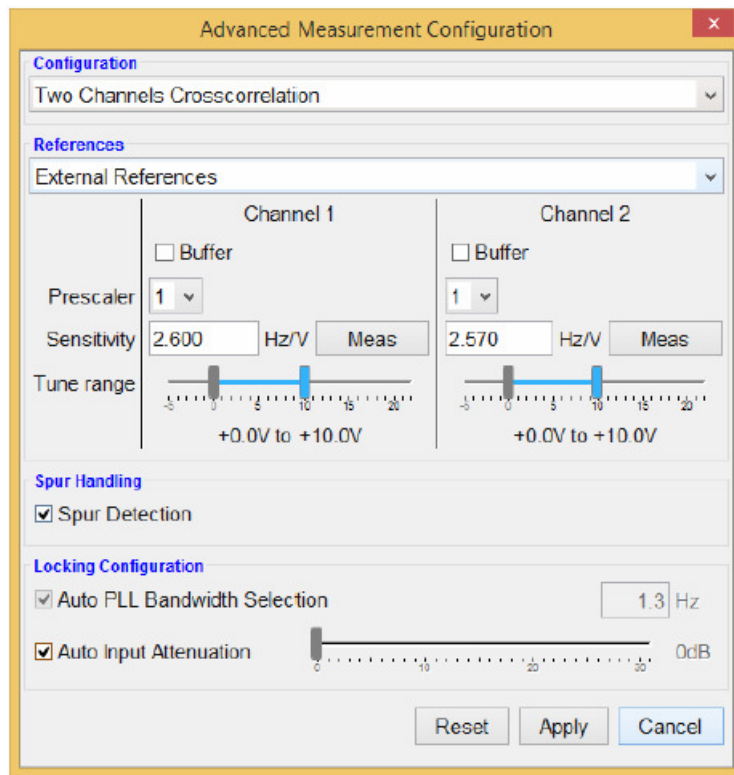

Fig. 7: PNT GUI Setup to Enable and Calibrate External References.

The Measurement Results

Once the calibration is completed, a click on the measurement button starts the measurement. In this example, the offset range is set from 1.0 Hz to 5.0 MHz and a total of 10 correlations. Figure 8 below shows the phase noise trace after the first correlation and Figure 9 the same after 10 correlations are completed. Comparing the results after 1 resp. 10 correlations shows a very good agreement. The longer measurement time for 10 correlations just leads to a "smoother" trace.

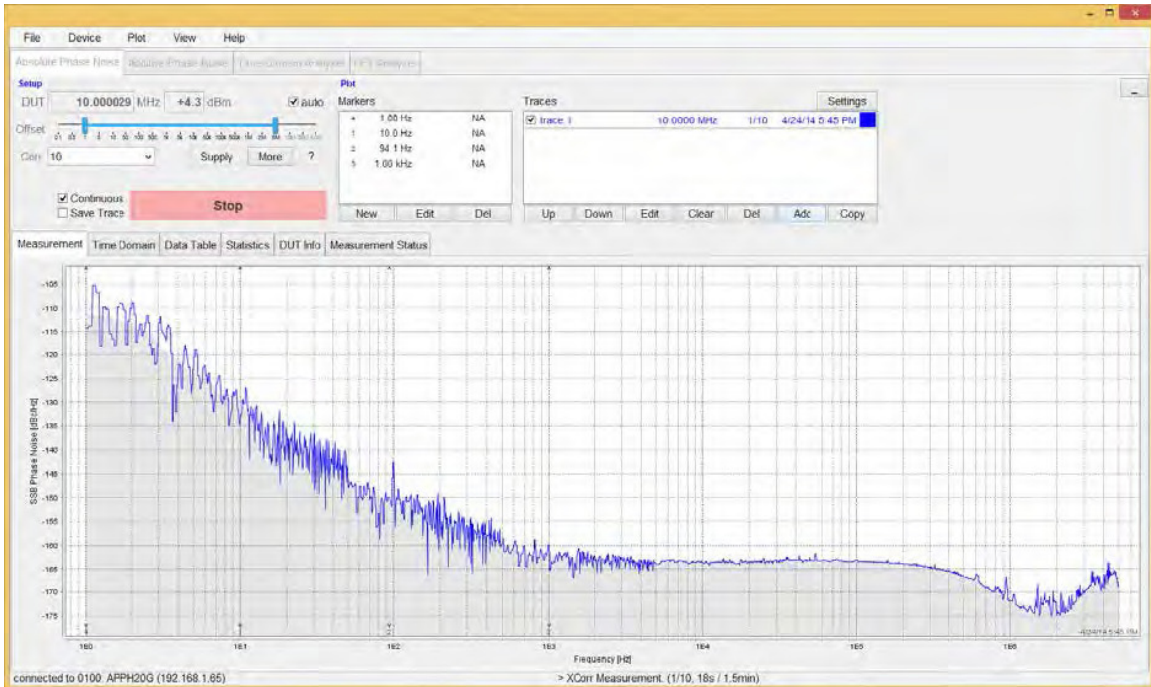

Figure 8: Blue Trace Shows Measurement Result after First Correlation (16 seconds measurement time).

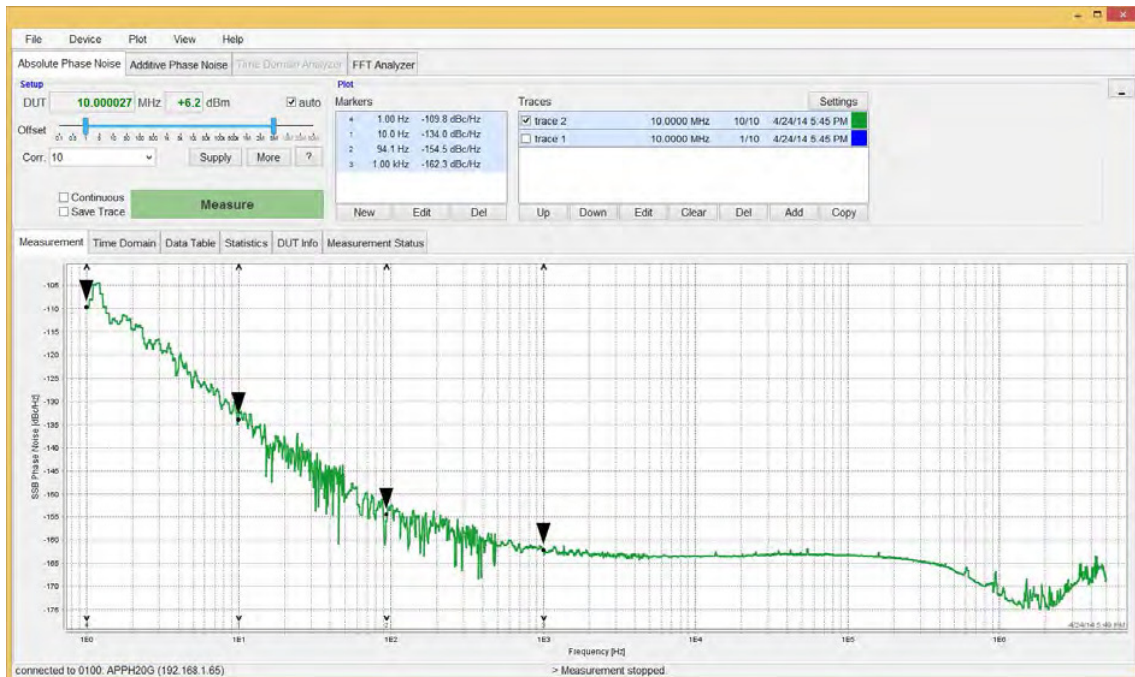

Fig 9: Final Measurement after Just 10 correlations (160 seconds measurement time)

Finally, the measurement results using internal and external results are compared below in Figure 10. As expected, measurements using internal references (green trace after 1st correlation, red trace after 200 correlations) are in exact agreement with the purple trace (external references, 10 correlations) for offsets larger than 100 Hz. For offsets below 100 Hz, using external references yields the correct result after just a few correlations.

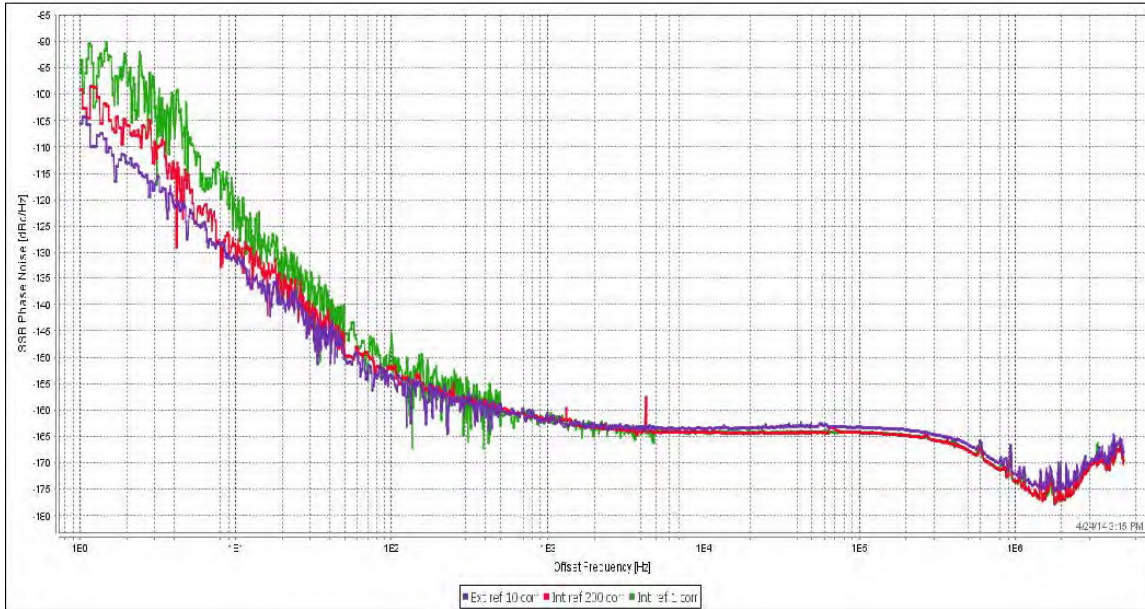

Fig. 10: Phase Noise Measurement of Low-Noise 10 MHz with Internal References (green and red trace) and External References (purple trace, 10 correlations, 160 seconds measurement time)

Conclusion

In conclusion, the PNT offers great flexibility in configuring your measurement to the required performance level.

For most phase noise measurement applications, the use of the standard configuration with the internal references is the ideal choice providing easy to use reliable measurements.

For measurements of very low phase noise DUTs (especially close to the carrier below 10 Hz offset), the low-noise option of the internal references (option LN) or external references will offer lower instrument noise floors and substantially reduced measurement times.

With the help of the PNT GUI, the setup and calibration of external references is greatly simplified, offering an alternative way to perform ultra-low phase noise measurements in short amount of time.